



Slider M35 • Slider M50

SALICE

Slider M35 - M50



M35 e **M50** sono i sistemi complanari per vani di medie dimensioni con ante del peso massimo di 35 e 50 kg.

Grazie ai brevetti esclusivi della serie Slider e al rivoluzionario ammortizzatore magnetico, lo scorrimento è intuitivo, fluido e silenzioso.

M35, disponibile anche nella versione motorizzata Power, è dotato di una parte inferiore progettata per permettere il montaggio dei supporti tipici della cucina.

Dal canto suo **M50** si contraddistingue per la versatilità: adatto alle più diverse tipologie di ambienti, può essere impiegato con porte con altezza di 33 o 17 mm da terra.



Per le sue caratteristiche, **M35** è destinato soprattutto all'utilizzo in cucina, mentre **M50** è l'ideale per gli armadi della zona notte e per i contenitori impiegati in ufficio e negli spazi commerciali.





Slider M35

Slider M35



Informazioni tecniche

Sistema di scorrimento complanare a due ante con ammortizzatore magnetico. Per le sue caratteristiche, **M35** è destinato soprattutto all'utilizzo in cucina.

Caratteristiche ante:

- **peso massimo per singola anta:**
 - 35 Kg
- **larghezza:**
 - minimo 600 mm massimo 2000 mm
- **altezza:**
 - minimo 1200 mm massimo 2200 mm
- **spessore:**
 - con regolatore superiore incassato minimo 18 mm, massimo con maniglia 45 mm
 - con regolatore superiore esterno minimo 18 mm, massimo con maniglia 40 mm
- **materiale:** legno
- si possono utilizzare telai Clipper

Regolazione dell'anta:

- verticale ± 5 mm
- orizzontale ± 3.5 mm
- frontale: - superiore ± 3 mm
- inferiore ± 3 mm

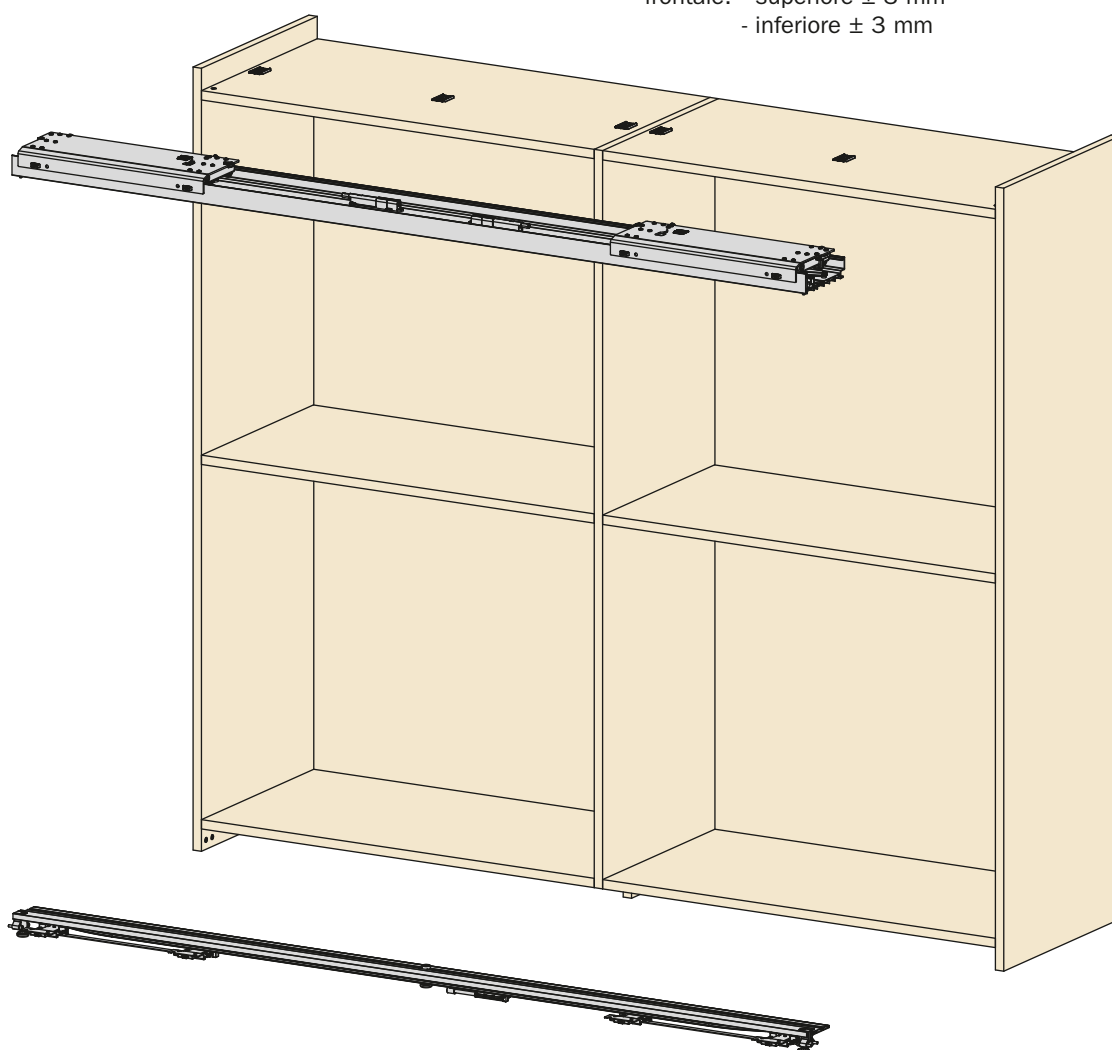

Caratteristiche principali

- Ammortizzazione con tecnologia magnetica.
- Massima semplicità di montaggio.
- Assoluta fluidità di scorrimento con ammortizzazione in apertura e chiusura.
- Elevata affidabilità, verificata con test di 100.000 cicli.

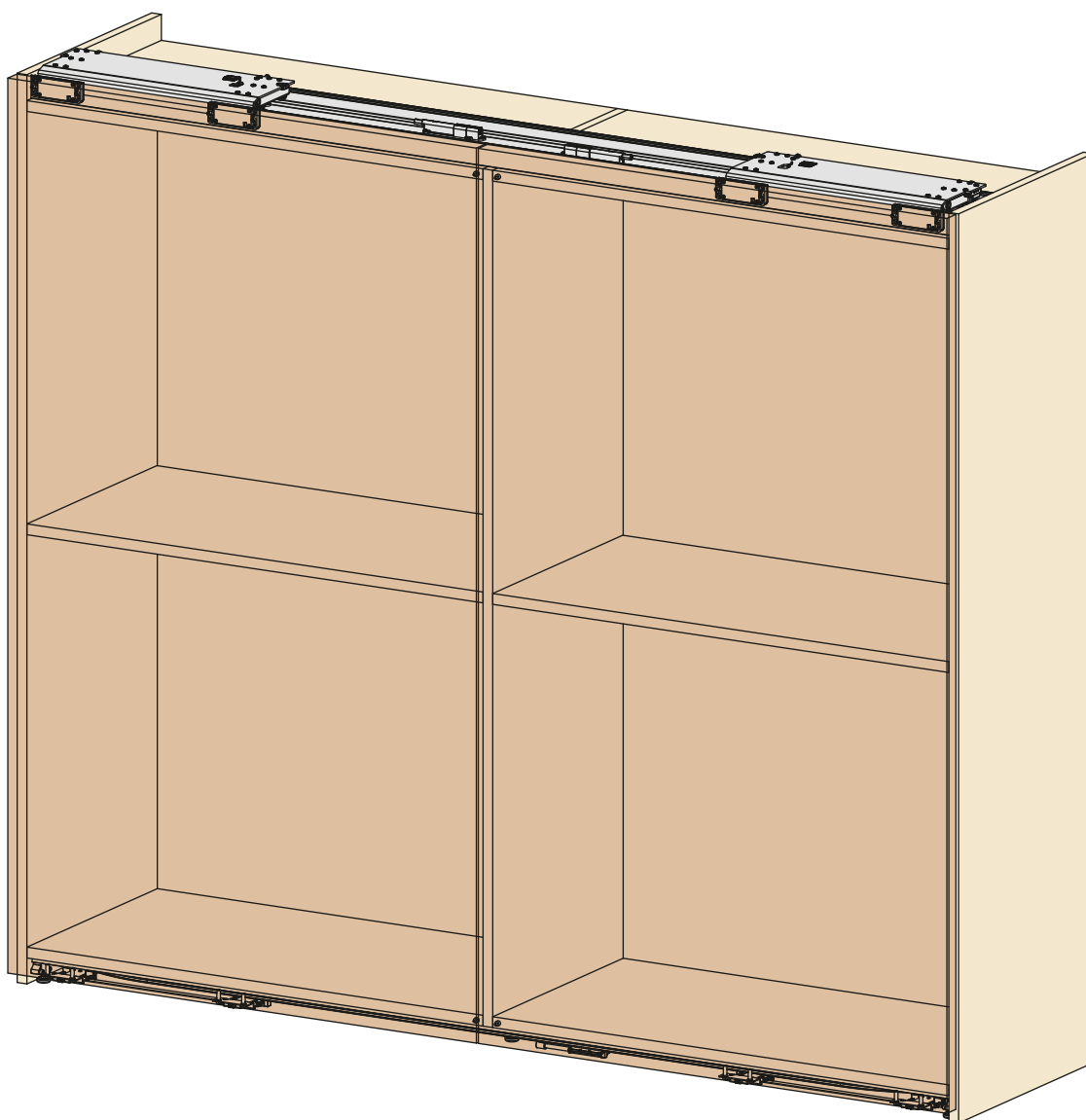

Slider M35 - Tipologie di montaggio

A27

Regolatori esterni

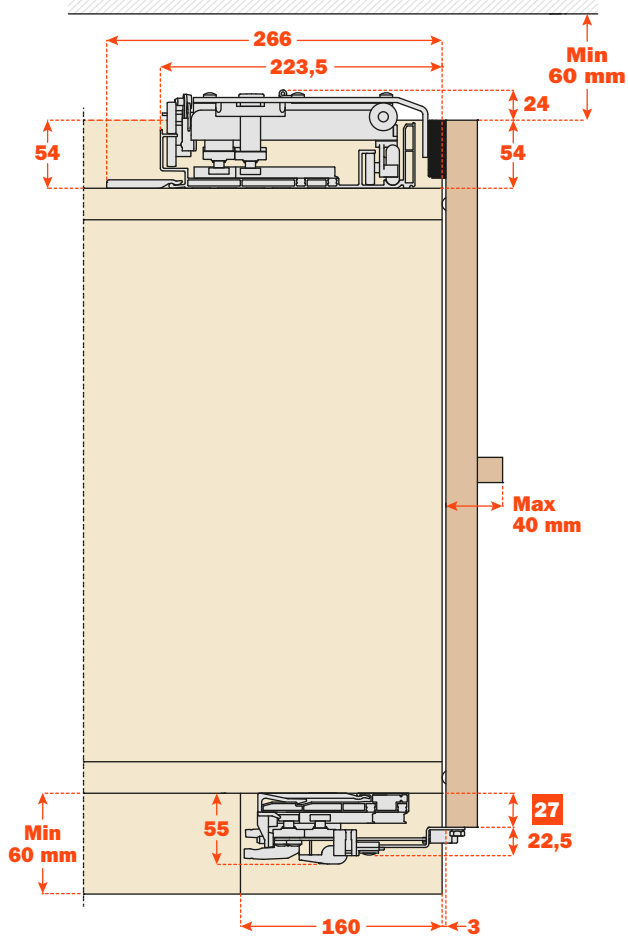

A27

Regolatori incassati

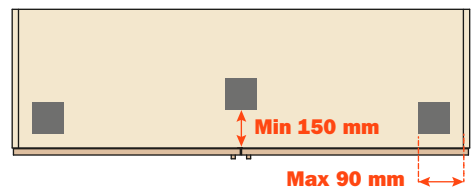
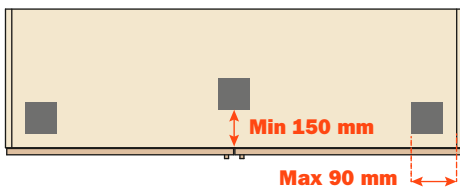
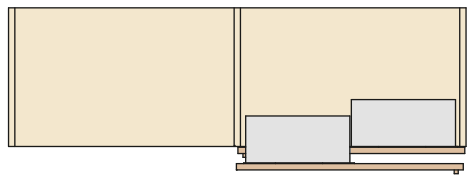
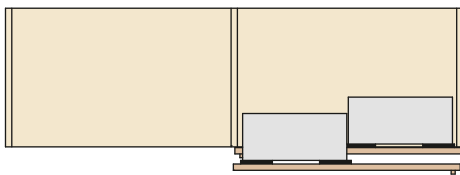
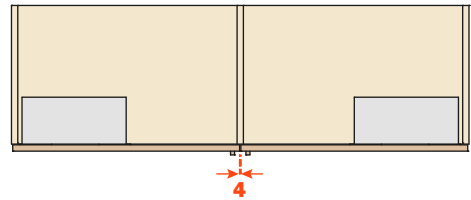
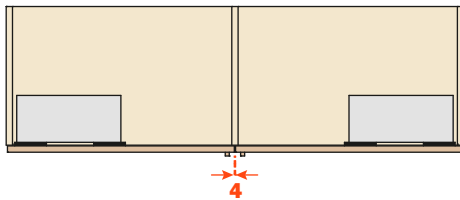
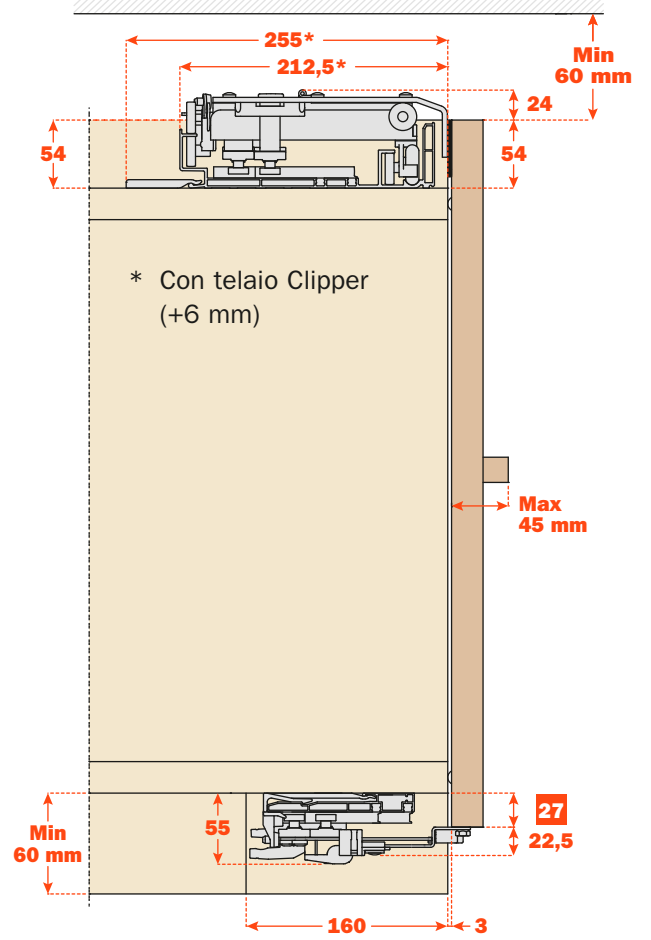

■ Piedino

A43
Regolatori esterni

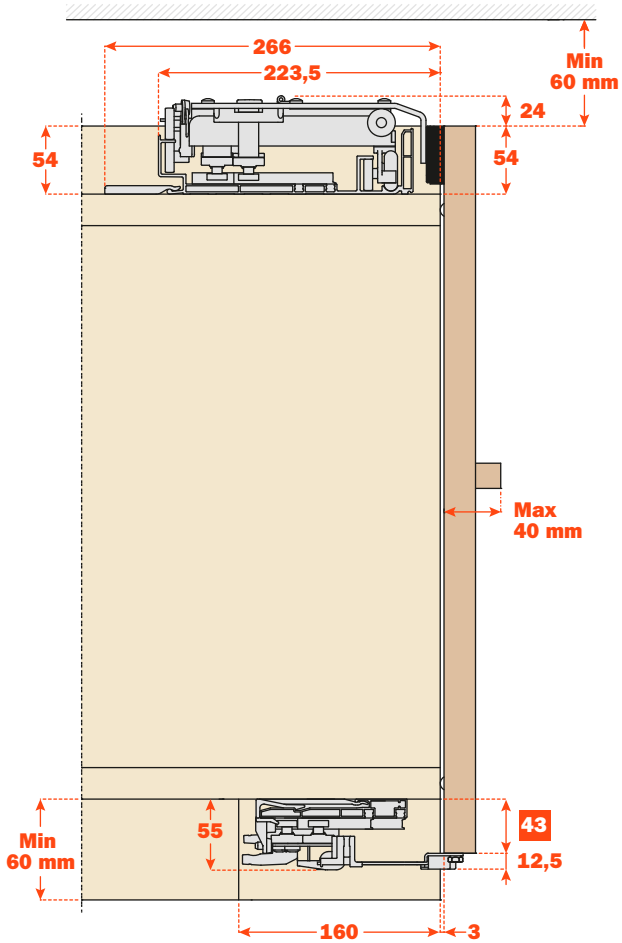

A43
Regolatori incassati

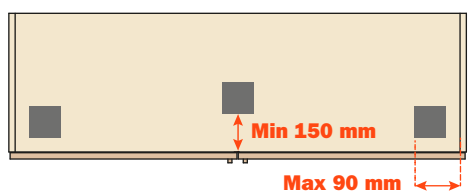
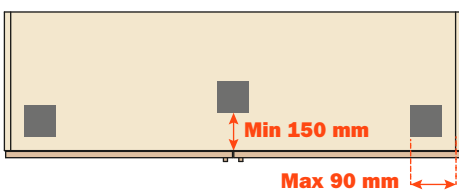
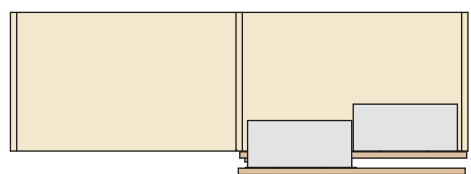
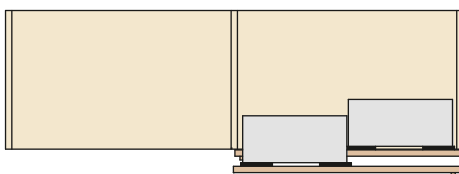
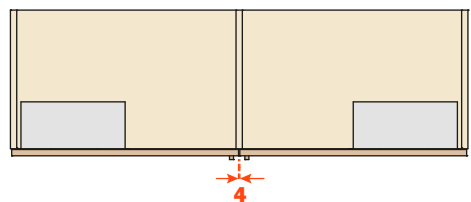
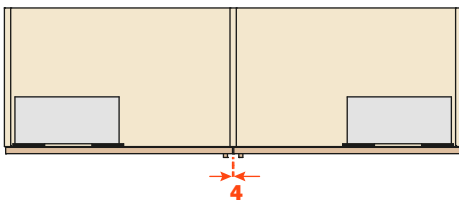
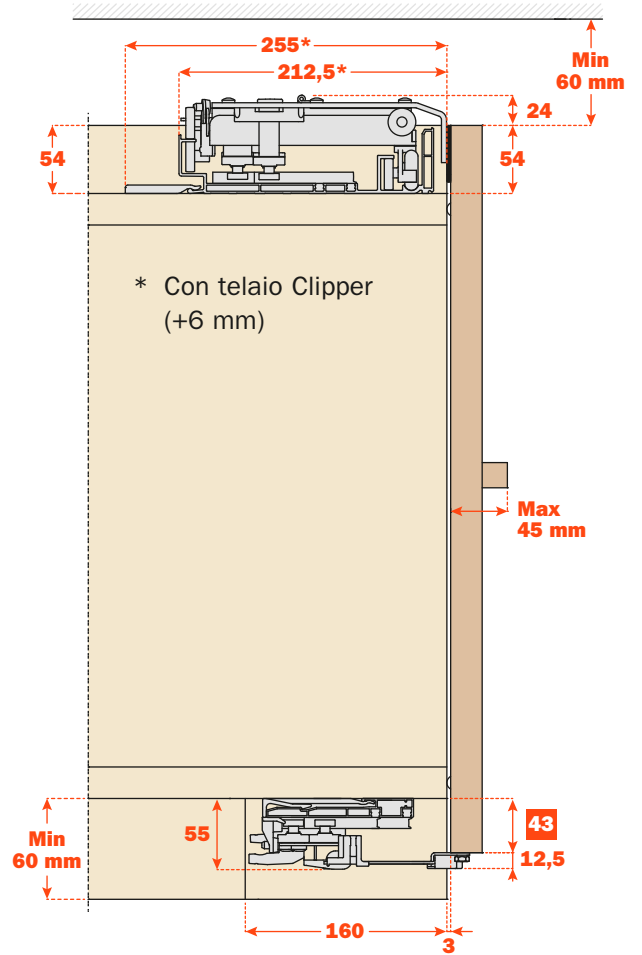

■ Piedino

Slider M35 - Tipologie di montaggio

B27

Regolatori esterni

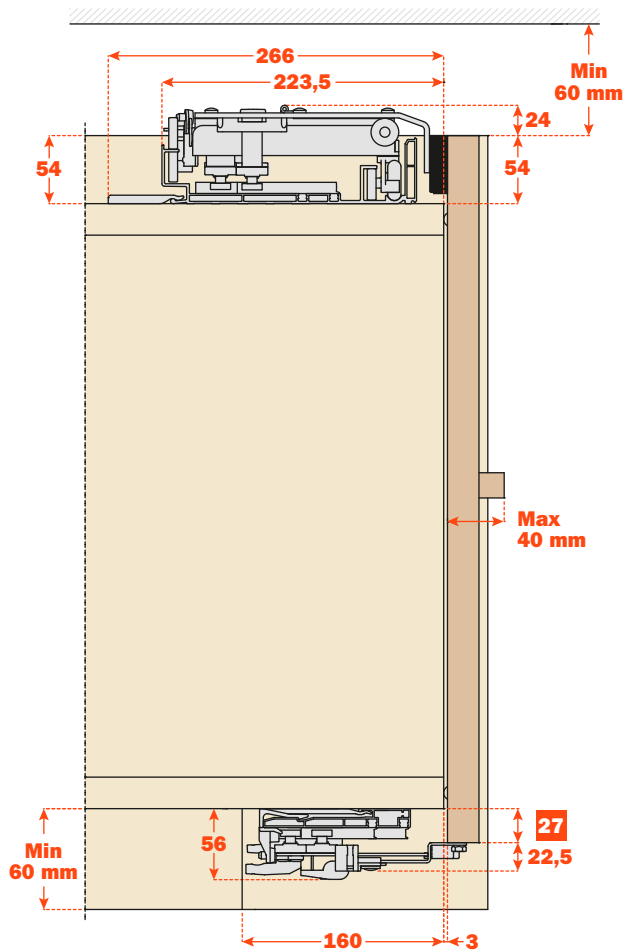

B27

Regolatori incassati

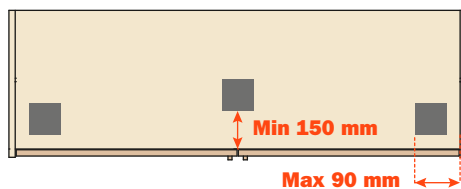
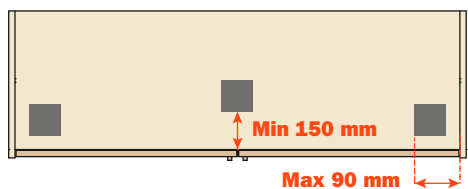
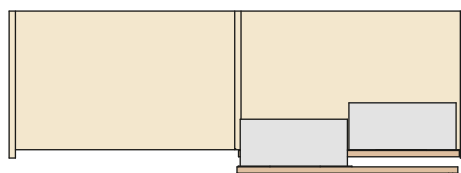
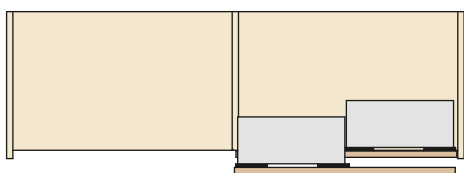
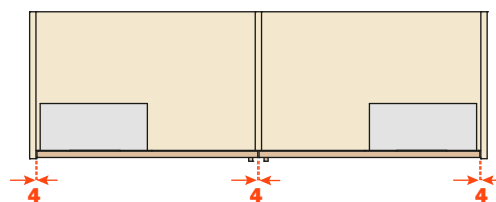
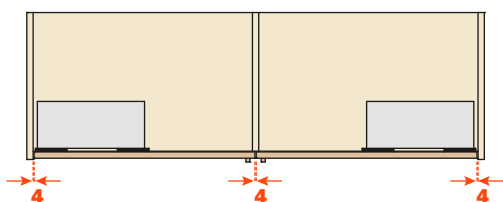
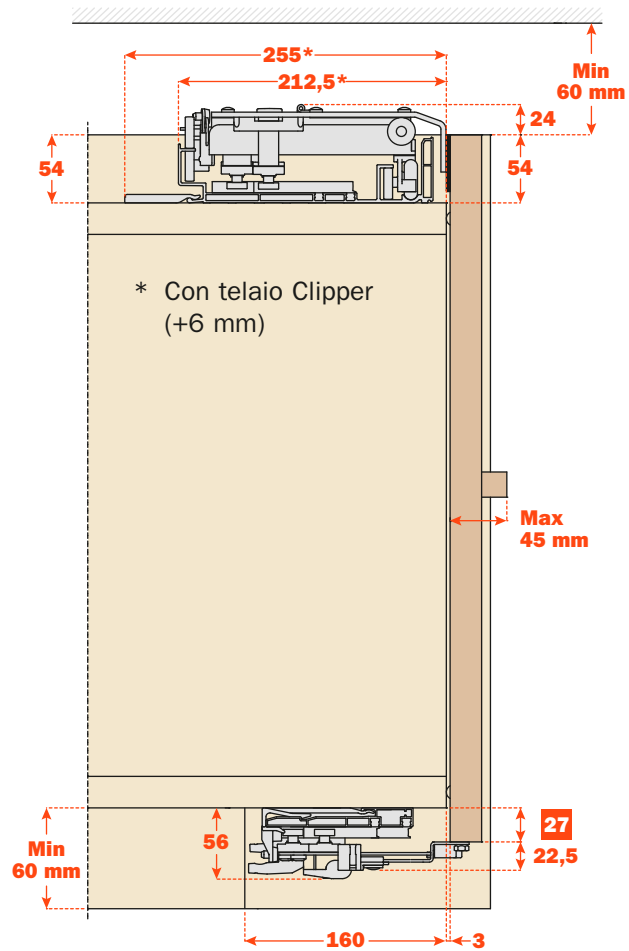

■ Piedino

B43
Regolatori esterni

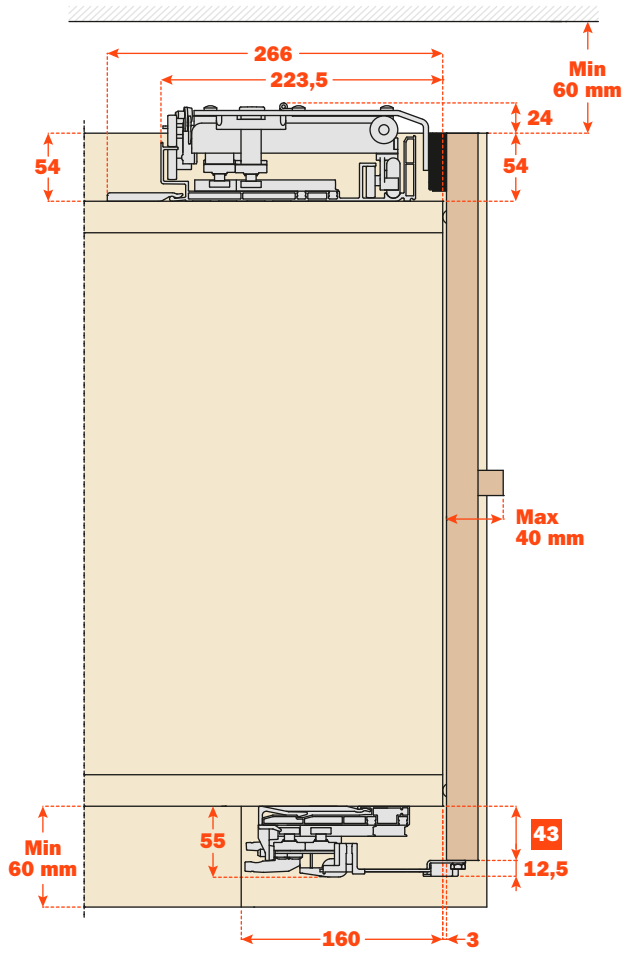

B43
Regolatori incassati

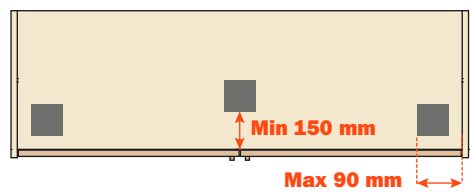
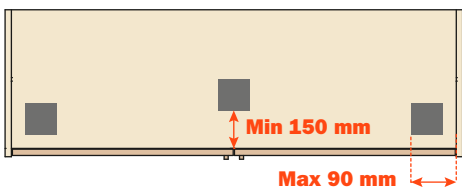
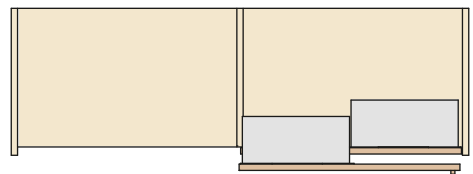
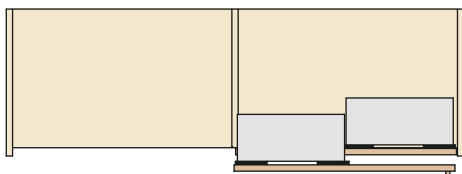
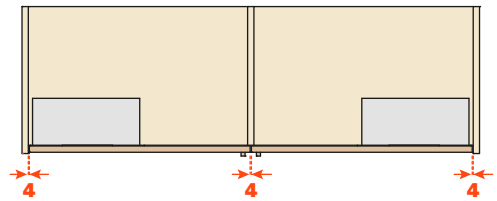
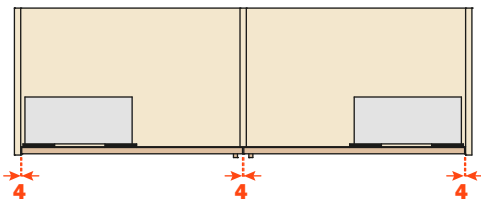
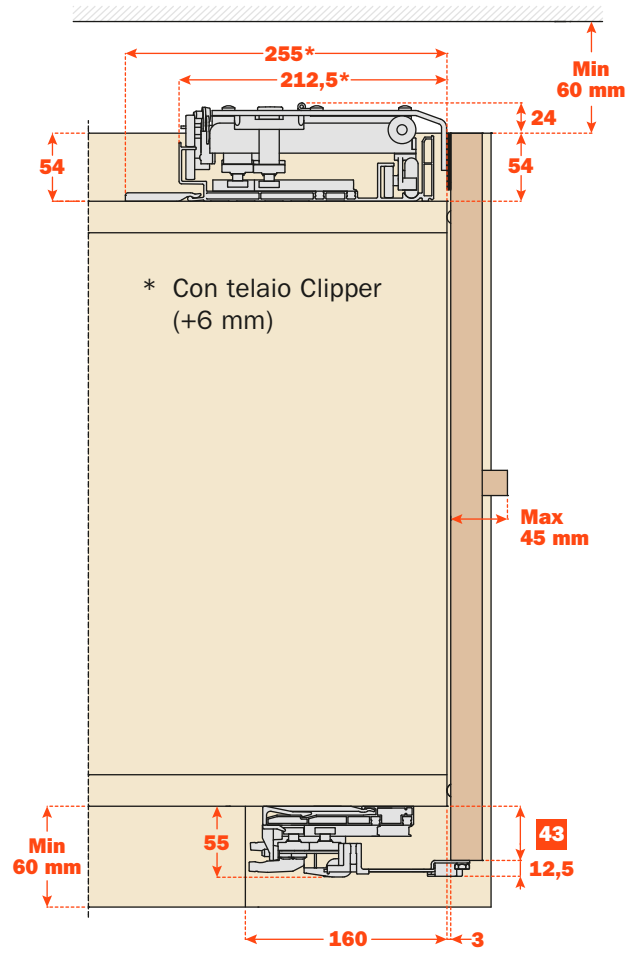

■ Piedino

Slider M35 - Come ordinare

Su misura

I meccanismi Slider M35 possono essere richiesti "su misura", cioè progettati per essere installati su contenitori con luce interna (**LI**) pari alla lunghezza dei binari (**CP**).

Attenzione: l'apertura delle ante può essere decisa dal cliente grazie alla variabile **RAA** (distanza tra la spalla centrale e il bordo dell'anta).

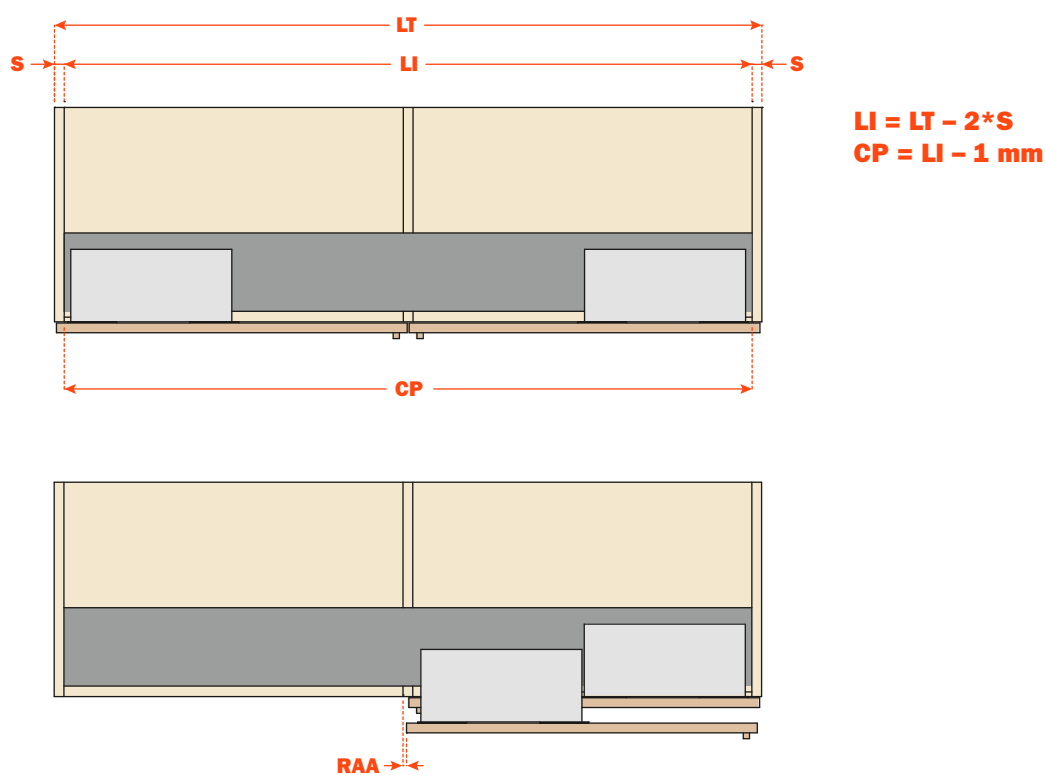



Slider M50

Slider M50



Informazioni tecniche

Sistema di scorrimento complanare a due ante con ammortizzatore magnetico.

Per le sue caratteristiche, **M50** è l'ideale per gli armadi della zona notte e per i contenitori impiegati in ufficio e negli spazi commerciali.

Caratteristiche ante:

- peso massimo per singola anta: 50 Kg
- larghezza: minimo 800 mm massimo 2000 mm
- altezza: minimo 1200 mm massimo 3000 mm

• spessore:

- con regolatore superiore incassato minimo 18 mm, massimo con maniglia 45 mm
- con regolatore superiore esterno minimo 18 mm, massimo con maniglia 40 mm

• materiale: legno

- si possono utilizzare telai Clipper

Regolazione dell'anta:

- verticale ± 5 mm
- orizzontale ± 3.5 mm
- frontale: - superiore ± 3 mm
- inferiore ± 3 mm

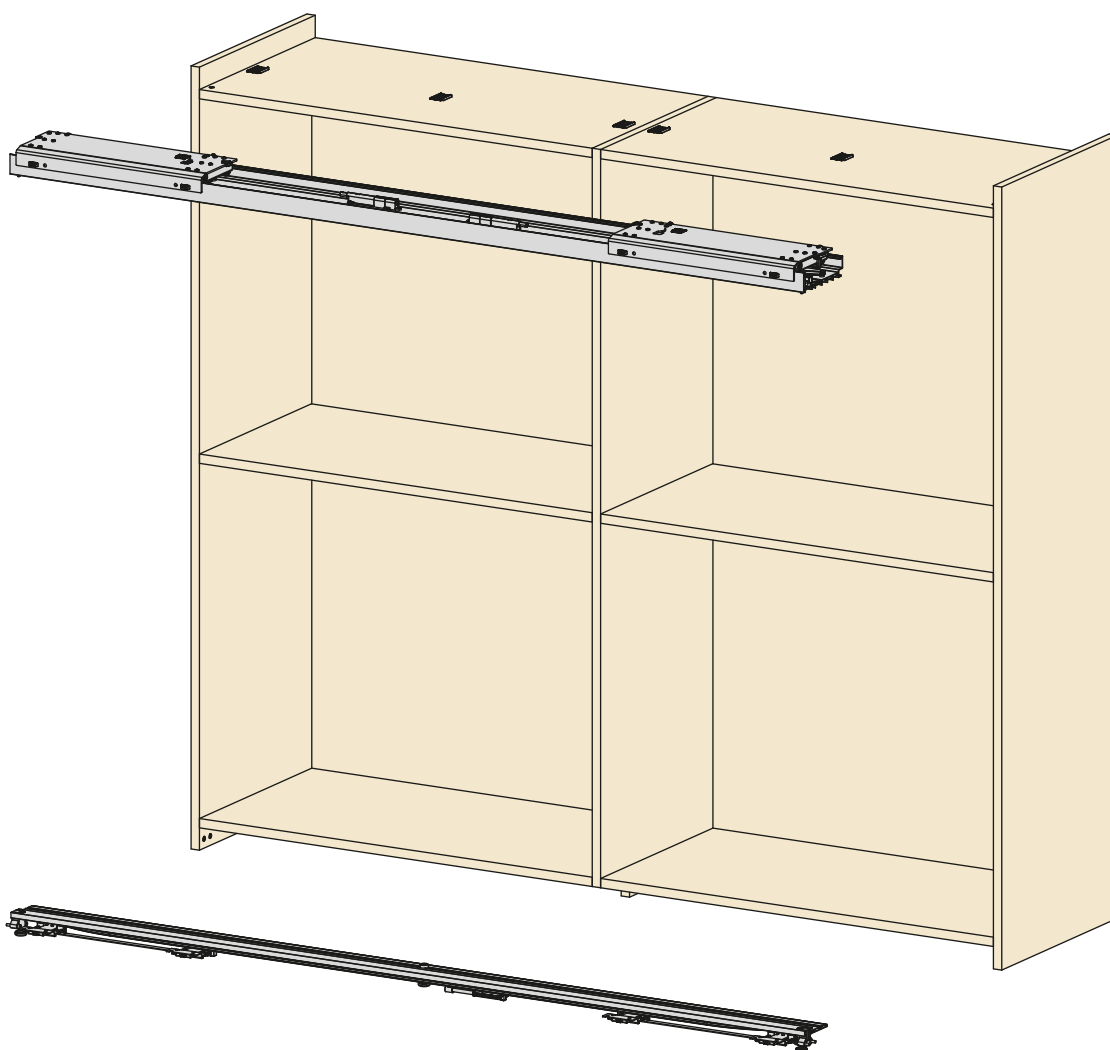

Caratteristiche principali

- Ammortizzazione con tecnologia magnetica.
- Massima semplicità di montaggio.
- Assoluta fluidità di scorrimento con ammortizzazione in apertura e chiusura.
- Elevata affidabilità, verificata con test di 100.000 cicli.

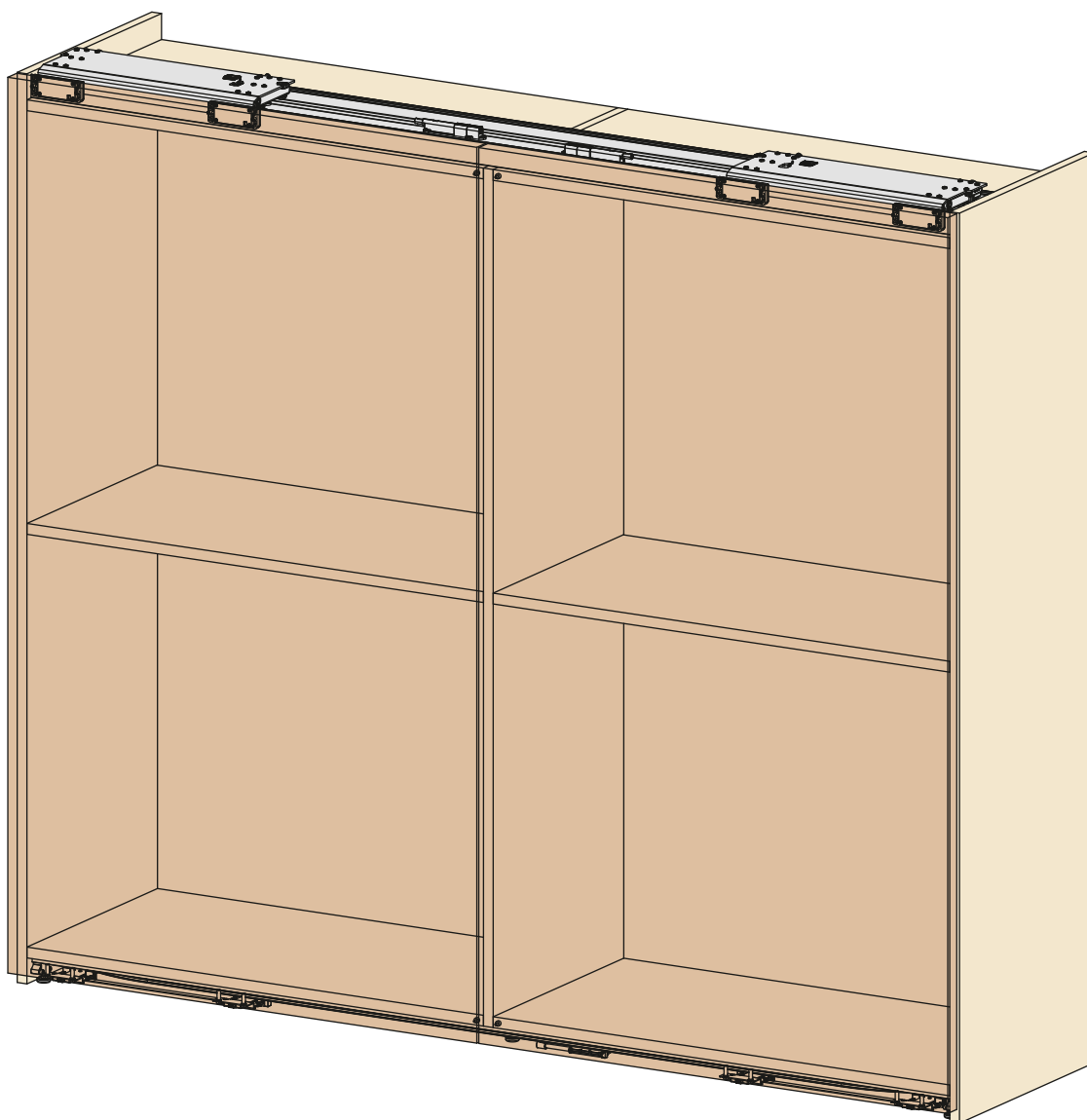

Slider M50 - Tipologie di montaggio

17 (M50)
Regolatori esterni

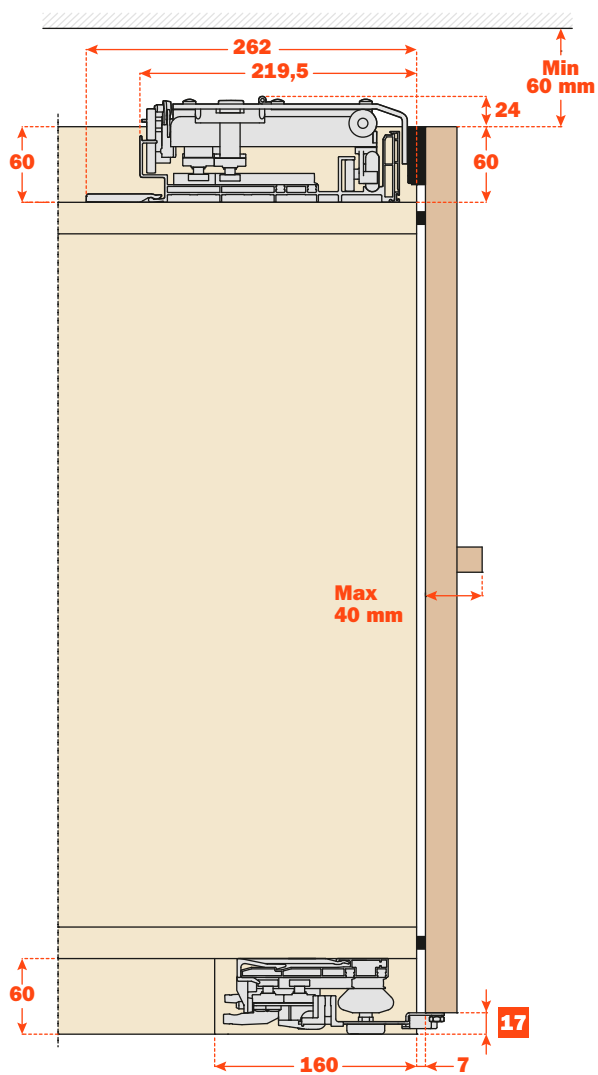

17 (M50)
Regolatori incassati

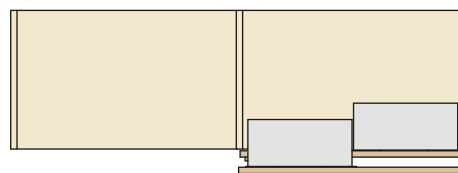
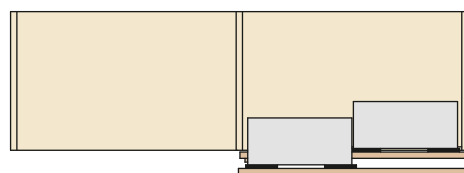
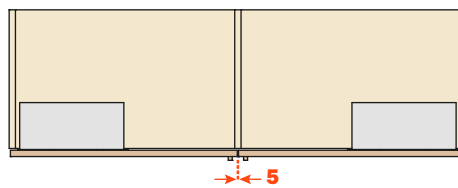
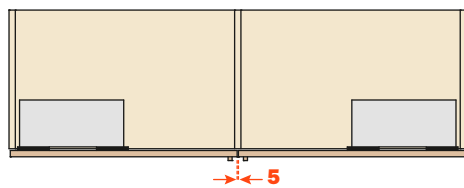
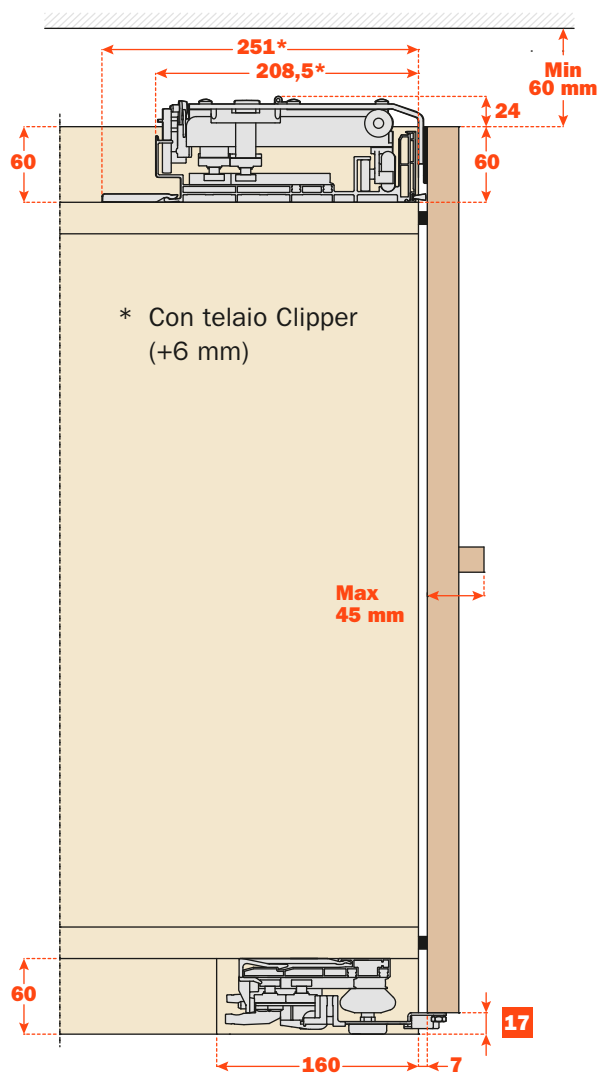

33 (M50)
Regolatori esterni

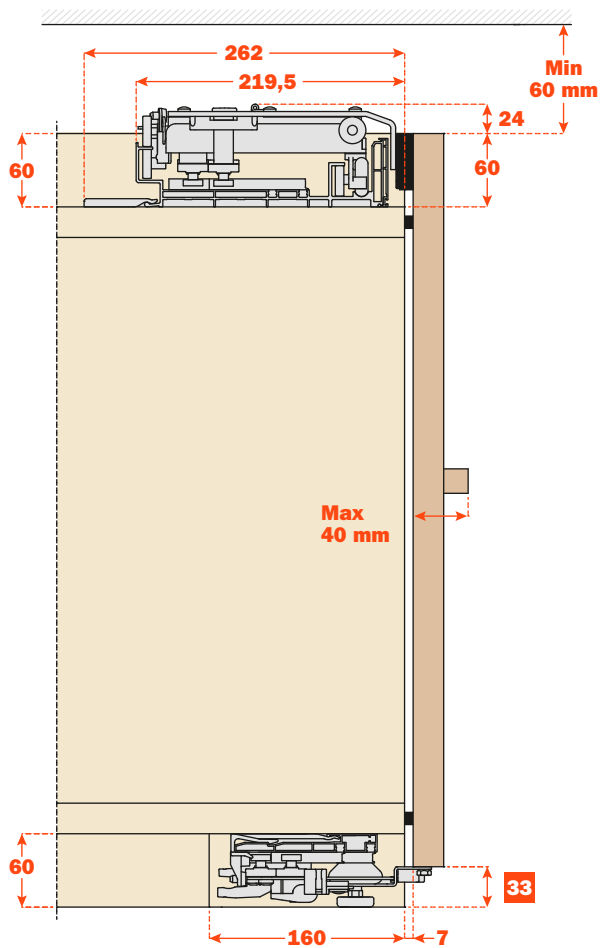

33 (M50)
Regolatori incassati

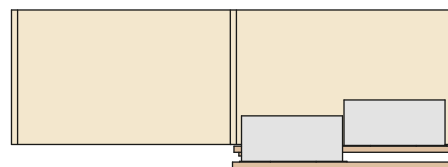
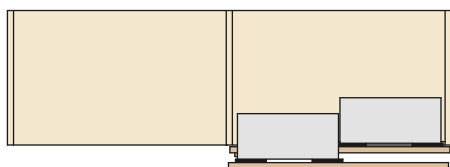
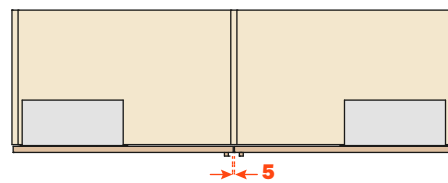
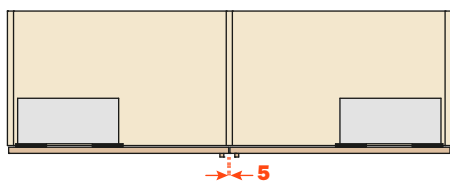
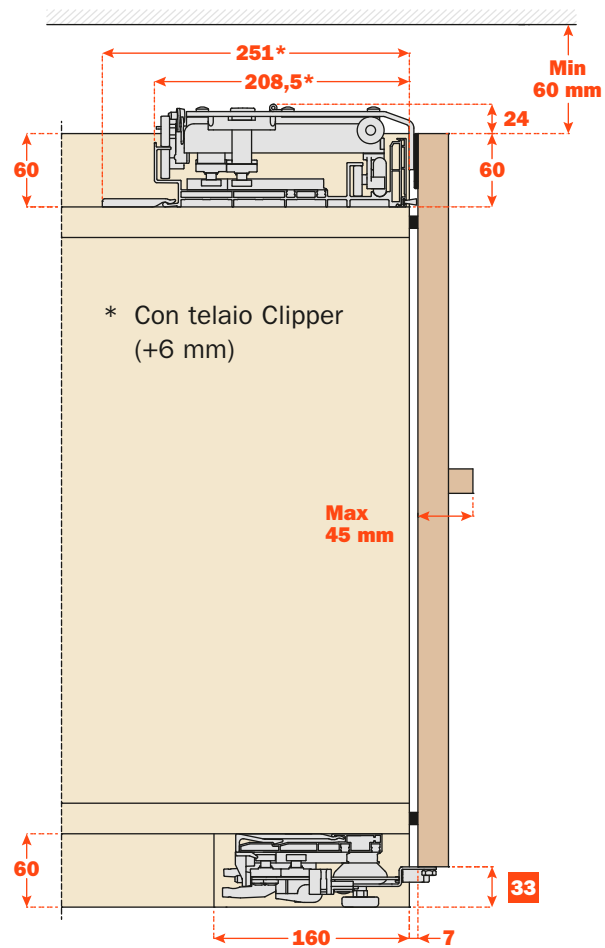

Slider M50 - Come ordinare M50

Su misura

I meccanismi Slider M50 possono essere richiesti "su misura", cioè progettati per essere installati su contenitori con luce interna (**LI**) pari alla lunghezza dei binari (**CP**).

Attenzione: l'apertura delle ante può essere decisa dal cliente grazie alla variabile **RAA** (distanza tra la spalla centrale e il bordo dell'anta).

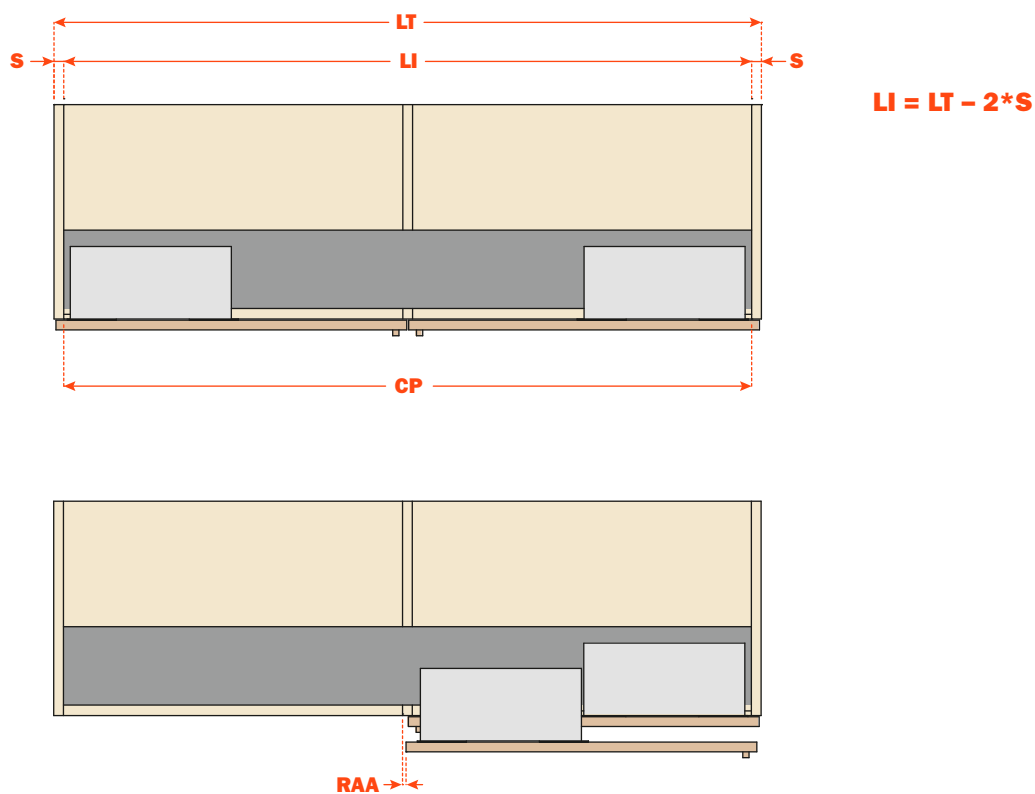

Standard

I meccanismi Slider M50 possono essere “standard”, cioè progettati per essere installati su contenitori con luce interna (**LI**) fino a 200 mm maggiore della lunghezza dei binari (**CP**) (Fig. **A**).

Attenzione: l'apertura delle ante potrà risultare ridotta (vedi formula Fig. **B**).

Fig. **A**

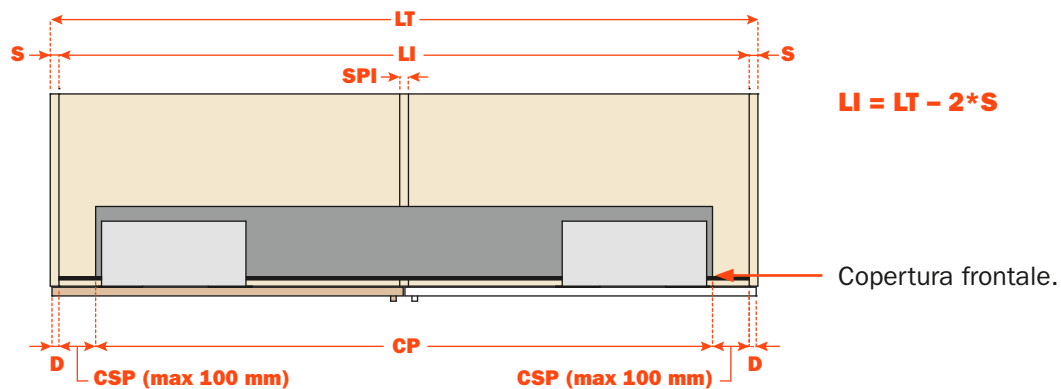
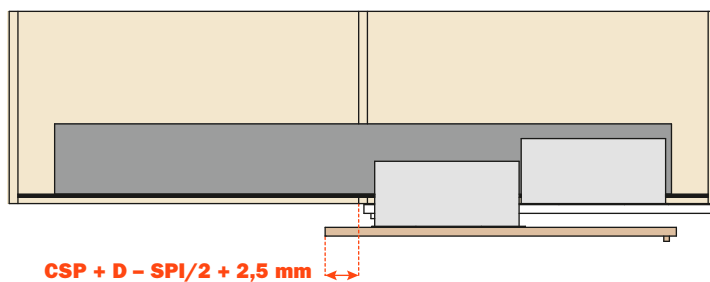
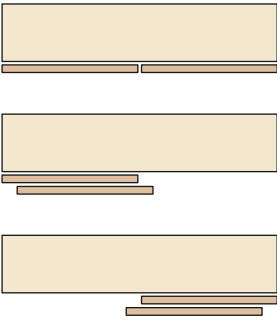

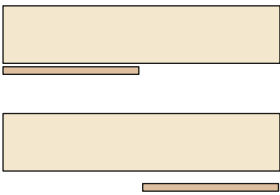

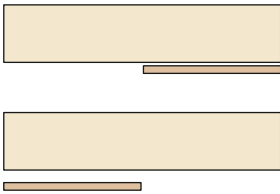

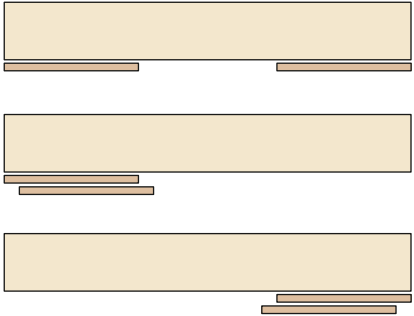

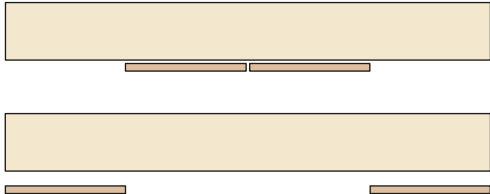



Fig. **B**



Descrizione		Codice	LI (mm)	CP (mm)
Slider M50 2 ante	SM16-18	VE51FB01600NN	1600÷1799	1599
	SM18-20	VE51FB01800NN	1800÷1999	1799
	SM20-22	VE51FB02000NN	2000÷2199	1999
	SM22-24	VE51FB02200NN	2200÷2399	2199
	SM24-26	VE51FB02400NN	2400÷2599	2399
	SM26-28	VE51FB02600NN	2600÷2799	2599
	SM28-30	VE51FB02800NN	2800÷2999	2799
	SM30-32	VE51FB03000NN	3000÷3199	2999
	SM32-34	VE51FB03200NN	3200÷3399	3199
	SM34-36	VE51FB03400NN	3400÷3599	3399
	SM36-38	VE51FB03600NN	3600÷3799	3599
	SM38-40	VE51FB03800NN	3800÷3999	3799

Slider M35 - M50 Versioni disponibili

<p>Standard</p>		<p>Slider M35 Slider M50</p>	 <p>Slider M35</p>
<p>One</p>		<p>Slider M35 Slider M50</p>	 <p>Slider M35</p>
<p>One</p>		<p>Slider M35 Slider M50</p>	 <p>Slider M35</p>
<p>Step</p>		<p>Slider M35 Slider M50</p>	 <p>Slider M35</p>
<p>Reverso</p>		<p>Slider M35 Slider M50</p>	 <p>Slider M35</p>

ARTURO SALICE S.p.A.

VIA PROVINCIALE NOVEDRATESE, 10
22060 NOVEDRATE (COMO) ITALIA
TEL. 031 790424 - FAX 031 791508
info.salice@salice.com - www.salice.com

DEUTSCHE SALICE GMBH

RUDOLF DIESEL STR. 10
74382 NECKARWESTHEIM
TEL. 07133 9807-0
FAX. 07133 9807-16
info.salice@deutschesalice.de
www.salice.com

DEUTSCHE SALICE GMBH

VERKAUFSBÜRO NORD
RINGSTRASSE 36/A30 CENTER
32584 LÖHNE
TEL. 05731 15608-0
FAX. 05731 15608-10
vknord@deutschesalice.de
www.salice.com

SALICE UK LTD.

KINGFISHER WAY
HINCHINGBROOKE BUSINESS PARK
HUNTINGDON CAMBS PE 29 6FN
TEL. 01480 413831
FAX. 01480 451489
info.salice@saliceuk.co.uk
www.salice.com

BORTOLUZZI SISTEMI S.p.A.

VIA CADUTI 14 SETTEMBRE 1944, 45
32100 BELLUNO ITALIA
TEL. 0437 930866 - FAX 0437 931442
info@bortoluzzi.com - www.bortoluzzi.com

SALICE FRANCE S.A.R.L.

285 RUE DE GOA ZAC LES 3 MOULINS
06600 ANTIBES
TEL. 0493 330069
FAX. 0493 330141
info.salice@salicefrance.com
www.salice.com

SALICE ESPAÑA, S.L.U.

C/ AIGUAFREDA 4, P.I. AMETLLA PARK
08480 L'AMETLLA DEL VALLÈS (BARCELONA)
TEL. 0034 938 46 88 61
info.salice@saliceespana.es
www.salice.com

SALICE PORTUGAL UNIP. LDA

SHOWROOM:

TV SÁ E MELO 161 FA
4470-116 MAIA - PORTO
TEL: 00351 224 154 221
Info@saliceportugal.pt
www.salice.com

ARMAZÉM:

VIA ROTA DOS MÓVEIS I 399
4585-325 GANDRA

SALICE CHINA (SHANGHAI) CO. LTD.

1st FLOOR, B1 BLDG 928 MINGZHU ROAD
XUJING, QINGPU DISTRICT
SHANGHAI 201702 - CHINA
TEL. 021 3988 9880
FAX. 021 3988 9882
info.salice@salicechina.com
www.salicechina.com

SALICE INDIA PVT. LTD.

1001 & 1002, 10TH FLOOR,
CENTRUM, PLOT NO. C-3,
OPP. WAGLE PRABHAG SAMITI OFFICE,
MIDC AREA, WAGLE INDUSTRIAL ESTATE,
THANE - 400604, MAHARASHTRA
TEL. 022 20812050
info@saliceindia.com
www.salice.com

SALICE CANADA INC.

3500 RIDGEWAY DRIVE,
UNIT#1
MISSISSAUGA, ONTARIO, L5L 0B4
TEL. 905 820 8787
FAX. 905 820 7226
info.salice@salicecanada.com
www.salicecanada.com

SALICE AMERICA INC.

2123 CROWN CENTRE DRIVE
CHARLOTTE NC. 28227
TEL. 704 841 7810
FAX. 704 841 7808
info.salice@saliceamerica.com
www.saliceamerica.com

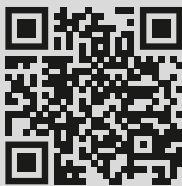

Contenuti digitali

Ci riserviamo il diritto di modificare le specifiche tecniche.



DOCASS011ITA Ed. 03 - 11/2023